

INSTALLATION INSTRUCTION

Model: VT-7252
VINTAGE SERIES



INTRODUCTION

Thank you for selecting and buying V-TAC LED Pendant light. V-TAC will serve you the best. Please read these instructions carefully before starting the installation and keep this manual handy for future reference. If you have any other query, please contact our dealer or local vendor from whom you have purchased the product. They are trained and ready to serve you at the best.

NOTES:

- Please turn off power and read this instruction before installation.
- The installation must be handled by a qualified electrician with license.
- Please also turn off power before changing the bulb and cleaning the fixture.

IMPORTANT SAFETY INSTRUCTIONS:

If you are unsure about your ceiling/wall type or what mounting method you should use, consult a qualified professional or your local hardware store. We recommend installation of this pendant lamp be performed by a licensed electrician.

INSTALLTION INSTRUCTIONS

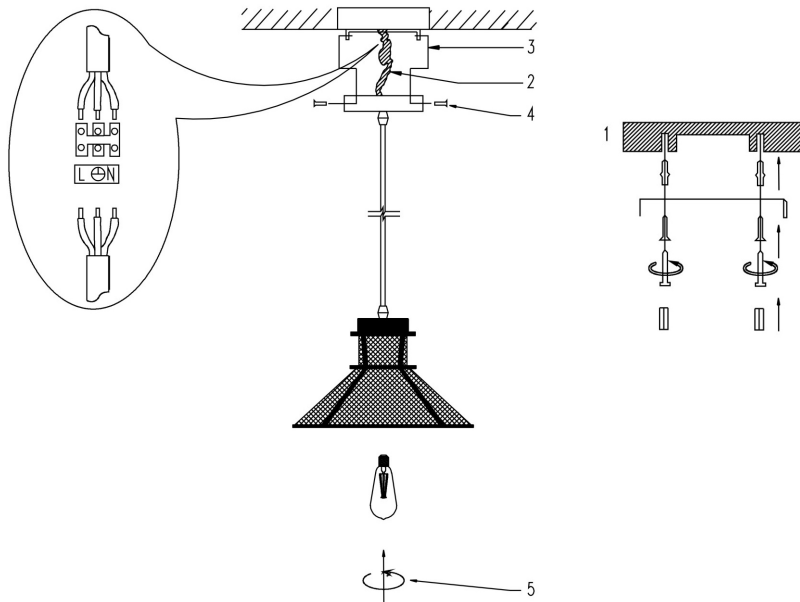

- A. Use screws to fix mounting bar to the junction box.
- B. Make the wire connections with connectors .
Connect the live wire (L) from fitting to the live wire from main power supply.
Connect the neutral wire (N) from fitting to the neutral wire from main power supply.
Connect the earth wire from fitting to the earth wire from main power supply.
Please pay close attention to avoiding the wires exposing outside when wiring connections.
- C. Use screws to fix canopy to mounting bar .
- D. Use socket ring to fix shade to the socket.
- E. Install the bulb (not included) at recommended wattage to the socket.
- F. Check if the installation is completed and turn on the power.